

KLT-DMT-AR0234 V4.2

2.3MP OnSemi AR0234 Global Shutter MIPI Interface M12 Auto Focus Camera Module

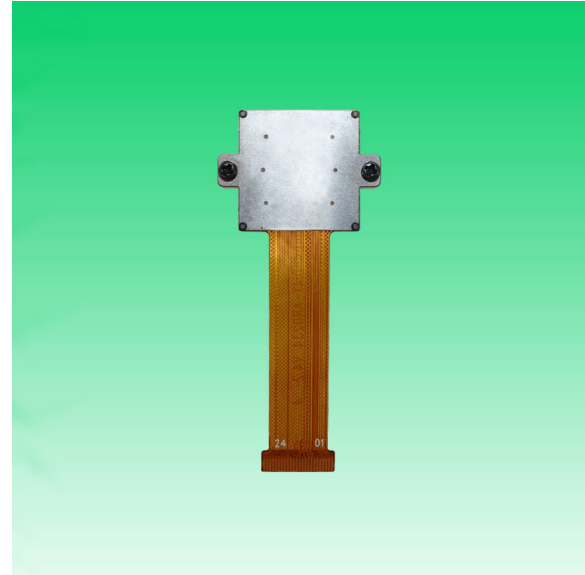

Front View



Back View

Specifications

Camera Module No.	KLT-DMT-AR0234 V4.2
Resolution	2.3MP
Image Sensor	AR0234 Global Shutter
Sensor Type	1/2.6"
Pixel Size	3.0 um x 3.0 um
EFL	6.03 mm
F.NO	2.10
Pixel	1920 x 1200
View Angle	68.0°(DFOV) 57.0°(HFOV) 35.0°(VFOV)
Lens Dimensions	20.00 x 20.00 x 23.99 mm
Module Size	61.00 x 26.00 mm
Module Type	Auto Focus
Interface	MIPI
Auto Focus VCM Driver IC	DW9714P
Lens Type	650nm IR Cut
Operating Temperature	-30°C to +70°C
Mating Connector	FH12-24S-0.5SH



KLT-DMT-AR0234 V4.2

2.3MP OnSemi AR0234 Global Shutter MIPI Interface M12 Auto Focus Camera Module



Top View

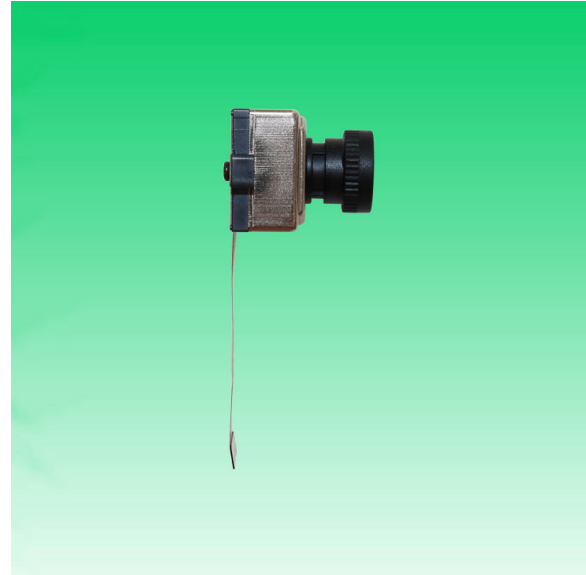

Side View



Bottom View

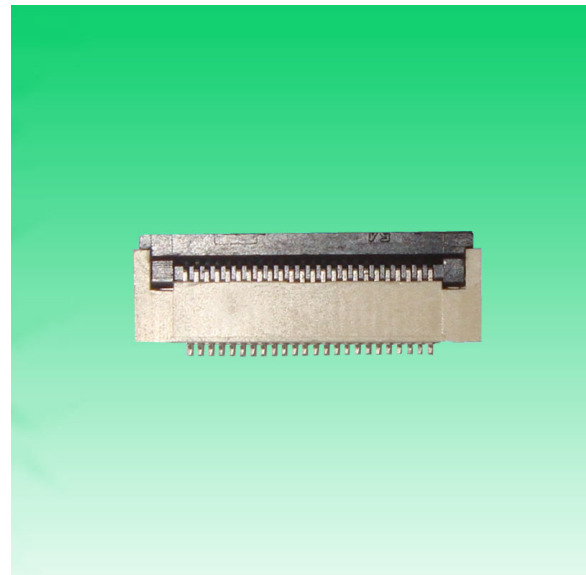

Mating Connector

RoHS	
PIN	SIGNAL
1	XSHUTDOWN
2	EXTCLK
3	RESET_BAR
4	SDATA
5	SCLK
6	AFVDD 2.8V
7	DOVDD 1.8V
8	DVDD 1.2V
9	AVDD 2.8V
10	AGND
11	CLK_P
12	CLK_N
13	DGND
14	DATA0_P
15	DATA0_N
16	DGND
17	DATA1_P
18	DATA1_N
19	DGND
20	DATA2_P
21	DATA2_N
22	DGND
23	DATA3_P
24	DATA3_N

Version	Information	Date
V1.0	First Version	11-29-2021
V1.4	Change IR Filter	10-12-2022
V4.2	Change VCM	11-30-2022

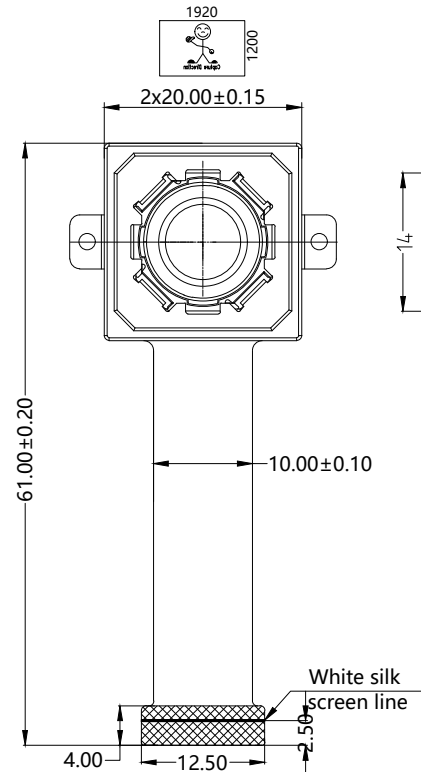

TOP VIEW

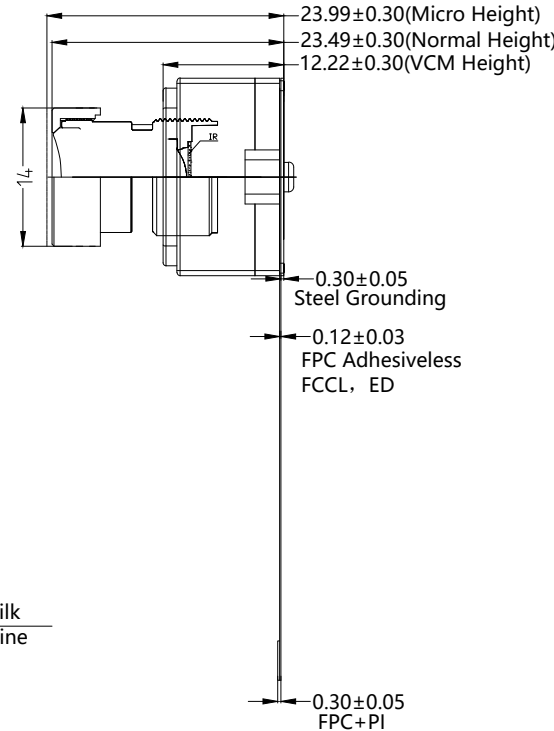

SIDE VIEW

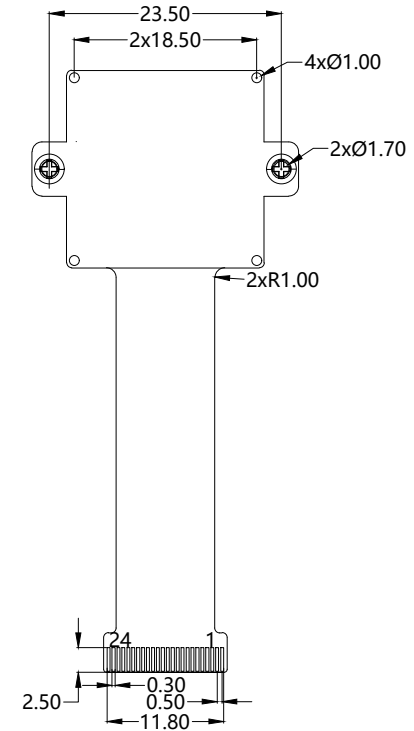

BOTTOM VIEW

NOTE:
 1.The device slave address:0x20(write);0x21(r);
 2.Driver IC:DW9714P

Parameter:

1、 Sensor specification:

Image Sensor: AR0234C5SC00SUKA0-CP

Pixel: 3.0um*3.0um

Lens Type: 1/2.6

Important Voltage Description:

DVDD1.2V (external power supply);

2、 Lens specification:

FOV: 68°(D);57°(H);35°(V)

F/NO.: 2.1

TV distortion: <-5%

Focal length: 6.03mm

Composition: 2G2P+IR FILTER

IR Cut Coating: 650nm±10nm@50%

Kai Lap Technologies Group Ltd

Designed By	Kevin	Model Name:	KLT-DMT-AR0234 V4.2		
Checked By	Aouly_Yan	Projection Type:	Unit: mm	Material: -----	
			Scale: 1:1	Sheet: 1 of 1	Version: 1/0

AR0234CS

1/2.6-inch 2.3 Mp CMOS Digital Image Sensor with Global Shutter

Product Overview

For complete documentation, see the data sheet.

The AR0234CS is a 1/2.6-inch 2Mp CMOS digital image sensor with an active-pixel array of 1920 (H) x 1200 (V). It incorporates a new innovative global shutter pixel design optimized for accurate and fast capture of moving scenes at 120 frame per second, full resolution. The sensor produces clear, low noise images in both low-light and bright scenes. It includes sophisticated camera functions such as auto exposure control, windowing, row skip mode, column-skip mode, pixel-binning, and both video and single frame modes. It is programmable through a simple two-wire serial interface. The AR0234CS produces extraordinarily clear, sharp digital pictures with an industry leading Global Shutter Efficiency, and its ability to capture both continuous video and single frames makes it the perfect choice for a wide range of applications, including scanning, autonomous mobility, surveillance and industrial quality control.

Features

- Best in Class Global Shutter Efficiency
- Low Dark Current/Hot Pixels
- High Linear Full Well
- Low Operational Power
- Small Form Factor
- Built-In Statistics Engine
- Multiple Functional Modes - Row & Col Skip Modes, Pixel Binning

Applications

- Gesture recognition
- 3D scanning
- Position tracking
- Machine vision
- AR/VR/MR/XR

































Benefits

- Superior Image Quality for fast-moving objects
- Reduced Total Noise Floor, Higher SNR delivering High Image Fidelity
- High Dynamic Range, delivers higher image clarity
- Suitable of Battery Powered Applications
- Ideal for Space Constrained Applications
- Offloads Image Processor Loads, provides scene details with Prog. ROI
- Application-specific Image Quality Selections with Performance/Power Trade-offs

End Products

- Autonomous Mobile Robots
- Autonomous Guide Vehicles (Drones)
- Video Doorbells
- AR/VR/MR Headsets
- Barcode Readers

Part Electrical Specifications

Product	Pricing (\$/Unit)	Compliance	Status	Type	Megapixels	Frame Rate (fps)	Optical Format	Shutter Type	Pixel Size (µm)	Output Interface	Color	Package Type
AR0234CSSC00SUD20		 	NEW	CMOS	2.3	120	1/2.6 inch	Global Shutter	3.0 x 3.0		Color	
AR0234CSSC00SUKA0-CP		 	Active	CMOS	2.3	120	1/2.6 inch	Global Shutter	3.0 x 3.0		Color	ODCSP-83
AR0234CSSC00SUKA0-CP1		 	Active	CMOS	2.3	120	1/2.6 inch	Global Shutter	3.0 x 3.0		Color	ODCSP-83
AR0234CSSC00SUKA0-CR		 	Active	CMOS	2.3	120	1/2.6 inch	Global Shutter	3.0 x 3.0		Color	ODCSP-83
AR0234CSSC28SUD20		 	NEW	CMOS	2.3	120	1/2.6 inch	Global Shutter	3.0 x 3.0		Color	
AR0234CSSC28SUKA0-CP		 	Active	CMOS	2.3	120	1/2.6 inch	Global Shutter	3.0 x 3.0		Color	ODCSP-83
AR0234CSSC28SUKA0-CP1		 	Active	CMOS	2.3	120	1/2.6 inch	Global Shutter	3.0 x 3.0		Color	ODCSP-83
AR0234CSSC28SUKA0-CR		 	Active	CMOS	2.3	120	1/2.6 inch	Global Shutter	3.0 x 3.0		Color	ODCSP-83
AR0234CSSM00SUD20		 	NEW	CMOS	2.3	120	1/2.6 inch	Global Shutter	3.0 x 3.0		Mono	
AR0234CSSM00SUKA0-CP		 	Active	CMOS	2.3	120	1/2.6 inch	Global Shutter	3.0 x 3.0		Mono	ODCSP-83
AR0234CSSM00SUKA0-CP1		 	Active	CMOS	2.3	120	1/2.6 inch	Global Shutter	3.0 x 3.0		Mono	ODCSP-83
AR0234CSSM00SUKA0-CR		 	Active	CMOS	2.3	120	1/2.6 inch	Global Shutter	3.0 x 3.0		Mono	ODCSP-83
AR0234CSSM28SUD20		 	NEW	CMOS	2.3	120	1/2.6 inch	Global Shutter	3.0 x 3.0		Mono	
AR0234CSSM28SUKA0-CP		 	Active	CMOS	2.3	120	1/2.6 inch	Global Shutter	3.0 x 3.0		Mono	ODCSP-83
AR0234CSSM28SUKA0-CP1		 	Active	CMOS	2.3	120	1/2.6 inch	Global Shutter	3.0 x 3.0		Mono	ODCSP-83
AR0234CSSM28SUKA0-CR		 	Active	CMOS	2.3	120	1/2.6 inch	Global Shutter	3.0 x 3.0		Mono	ODCSP-83

FEATURES

- 120mA output driver with 10-bit resolution DAC
- Smart Actuator Control (SAC™) modes
- Supply voltage (V_{DD}): 2.3V to 4.3V
- I/O voltage (V_{IN}): 1.8V to V_{DD}
- Fast mode and Fast mode plus I²C interface compatible
- Power On Reset (POR)
- Power Down (PD) mode current consumption less than 1uA
- Package: 6-pin WLCSP (0.77mm x 1.14mm x 0.30mm)

APPLICATIONS

- Mobile camera
- Digital still camera
- Camcorder
- Web camera
- Action camera

GENERAL DESCRIPTION

The DW9714P designed for linear control of Voice Coil Motors (VCM). This device is compatible with DW9714. The DW9714P has a single 10-bit DAC with 120mA output current sink capability. This device features SAC™ mode which can minimize the mechanical vibration and achieve very fast mechanical settling time. The SAC™ is protected by patent and registered trademark of DONGWOON ANATECH.

The DW9714P operates from a single 2.3V to 4.3V supply. The internal DAC is controlled via an I²C serial interface that operates at clock rate up to 1MHz. The I²C address for the DW9714P is 0x18. The DW9714P offers PD mode with current consumption less than 1uA.

The DW9714P can be used for auto focus applications in mobile cameras, digital still cameras, camcorders, web cameras and action cameras.

TYPICAL APPLICATION CIRCUIT

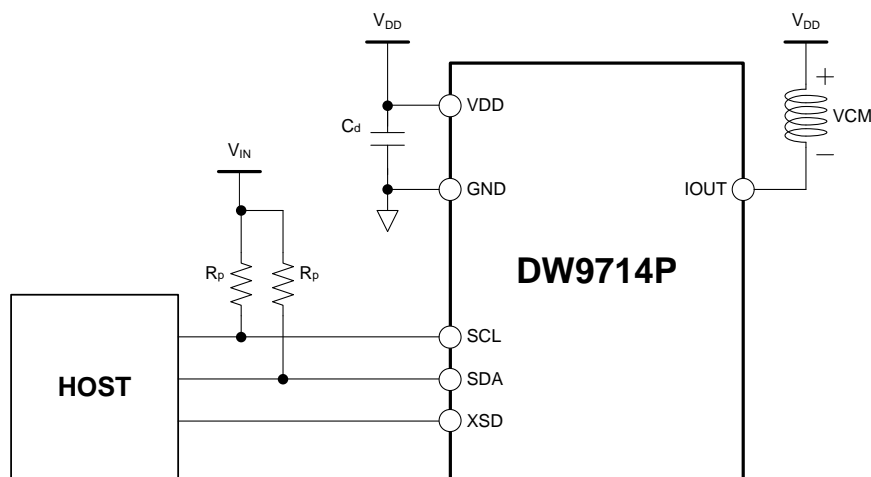
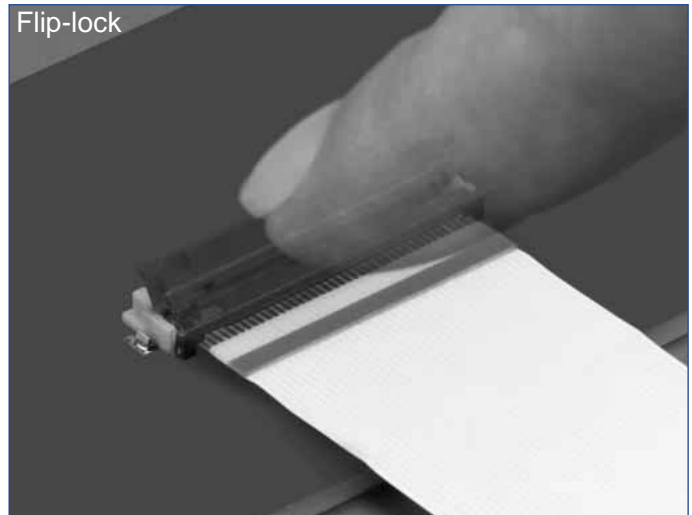
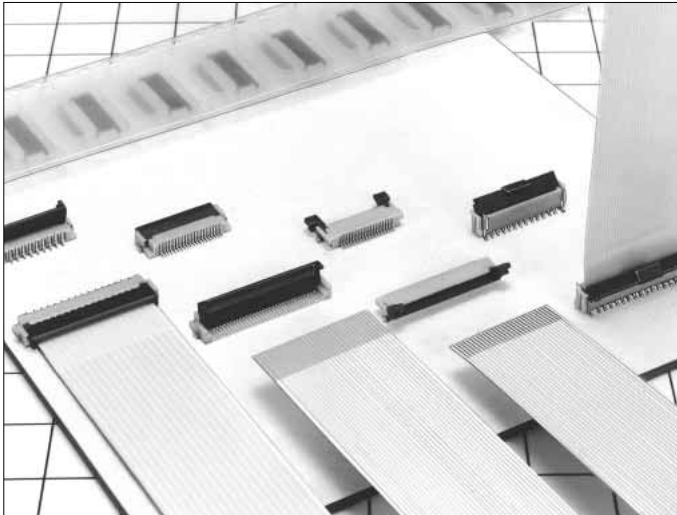

Figure 1. Typical application circuit

0.5mm and 1mm Pitch Connectors For FPC/FFC

FH12 Series



■ Features

1. Ease of Use and Space Savings

Only one finger or 6.9N (Newtons) of force is required to lock Hirose's rotational actuator (flip-lock) as compared to using 2 fingers and 39.2N to close a FFC/FPC connector from our competition.

The Flip-Lock design also allows customers to place 2 or more connectors side by side as there is no need to waste additional board space for a side latch.

2. Strengthened Flip-lock Actuator

The standard Flip-Lock requires only 2.0mm height above the board. A strengthened lock lever is available which only requires an additional 0.4mm.

3. Supports Thin FPC (0.18mm)

Hirose does not require double-sided FPC to have any additional strengthening plate or stiffener and can therefore support a thickness of as little as 0.18mm +/- 0.05.

4. Hirose Ensures Reliability

Hirose's patented half tuning fork contacts maintain the required normal force without relying on the connector housing. With our competitor's conventional products the housing walls support the contact force, which does not provide for long-term reliability.

5. Prevention of Solder Bridge

Excess solder cavity absorbs excessive solder and avoids solder bridging.

6. Three different assembly types

FH12 is offered in Top & Bottom Contact and Vertical Mount and offered in both a 0.5mm contact pitch as well as a 1.0mm contact pitch (bottom contact only).

■ Applications

Notebook computers, printers, PDAs, digital cameras and other compact devices for interconnecting the main circuit board with the LCD, HDD or other device.

Rotating One-touch Mechanism

①

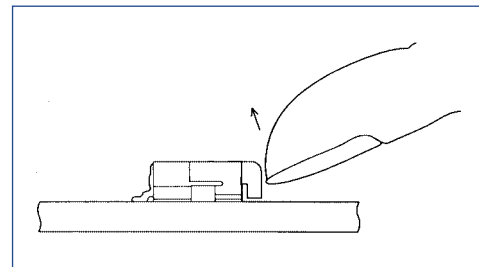

②

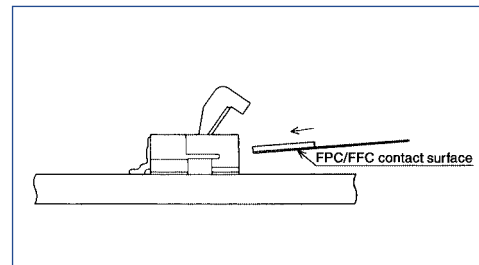

③

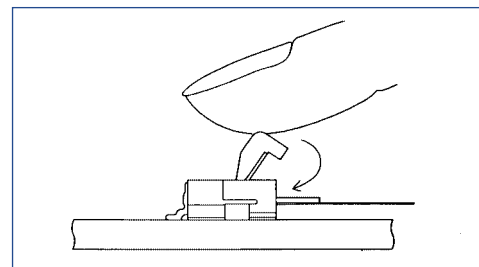

Product Specifications

Rating	Current rating: 0.5A DC(Note 1)	Operating Temperature Range: -40 to +70°C (Note 2)	Storage Temperature Range: -10 to +50°C (Note 3)
	Voltage rating: 50V AC	Operating Humidity Range: Relative humidity, 90% max. (Not dewed)	Storage Humidity Range: Relative humidity, 90% max. (Not dewed)

Applicable FPC	t=0.3±0.05 Gold plated	t=0.18 ± 0.05 for FH12F-*S-0.5SH
----------------	------------------------	----------------------------------

Item	Specification	Conditions
1. Insulation resistance	500M ohms minimum	100V DC
2. Withstanding voltage	No flashover or insulation breakdown.	150V AC/1 minute
3. Contact resistance	50m ohms maximum	1mA
4. Durability (Insertion/withdrawal)	Contact resistance: 50m ohms maximum No damage, cracks, or parts dislocation.	20 cycles
5. Vibration	No electrical discontinuity of 1μs or more Contact resistance: 50m ohms maximum. No damage, cracks, or parts dislocation.	Frequency: 10 to 55 Hz, single amplitude of 0.75 mm, 2 hours in each of the 3 directions.
6. Shock	No electrical discontinuity of 1μs or more Contact resistance: 50m ohms maximum. No damage, cracks, or parts dislocation.	Acceleration of 490 m/s ² , 11 ms duration, sine half-wave waveform, 3 cycles in each of the 3 axis.
7. Humidity(Steady state)	Contact resistance: 50m ohms maximum. Insulation resistance: 50M ohms minimum. No damage, cracks, or parts dislocation.	96 hours at 40°C and humidity of 90% to 95%
8. Temperature Cycle	Contact resistance: 50m ohms maximum. Insulation resistance: 50M ohms minimum. No damage, cracks, or parts dislocation.	Temperature: -40°C → 15 to 35°C → 85°C → 15 to 35°C, Time: 30 → 5 max. → 30 → 5 max.(minutes) 5 cycles
9. Resistance to Soldering heat	No deformation of components affecting performance.	Reflow: At the recommended temperature profile Manual soldering: 350±5°C for 3 seconds

Note 1: When passing the current through all of the contacts, use 70% of the current rating.

Note 2: Includes temperature rise caused by current flow.

Note 3: The term "storage" refers to products stored for long period of time prior to mounting and use. Operating Temperature Range and Humidity range covers nonconducting condition of installed connectors in storage, shipment or during transportation.

Material

Part	Material	Finish	Remarks
Insulator	Polyamide, LCP(60 pos.)	Color : Beige	UL94V-0
Actuator	PPS	Color : Dark brown	
Contact	Phosphor bronze	Gold plated	
Metal Fittings	Brass	Tin plated	

Ordering Information

FH12 **A** - **10** (**4**) - **S** **A** - **0.5** **SH** (**55**)
 ① ② ③ ④ ⑤ ⑥ ⑦ ⑧ ⑨

① Series Name : FH12	⑤ Contact alignment: Single
② Blank : standard type A : Top contact type S : Type with strengthened flip-lock actuator F : Type with 0.18mm FPC End Thickness	⑥ Eccentric direction: Blank : standard type A : Eccentric type
③ Standard type : Number of contacts Eccentric type : Number of contacts in 0.5mm housing	⑦ Contacts Pitch : 0.5mm, 1mm
④ Standard type : Blank Eccentric type : Number of contacts	⑧ Contact type SH : SMT horizontal mounting type SV : SMT vertical mounting type
	⑨ Plating specification (55) : Gold plated

FH12 Series 0.5mm and 1mm Pitch Connectors For FPC/FPC

Series Configuration

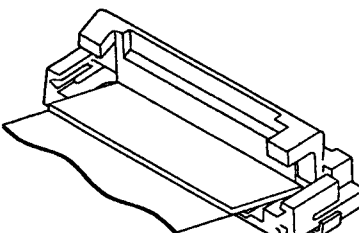
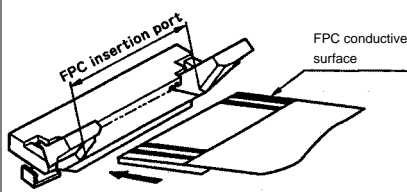
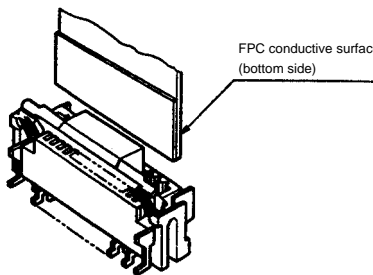
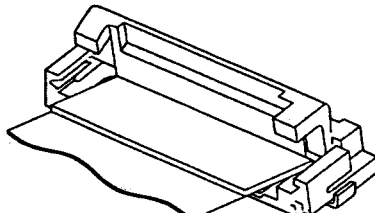
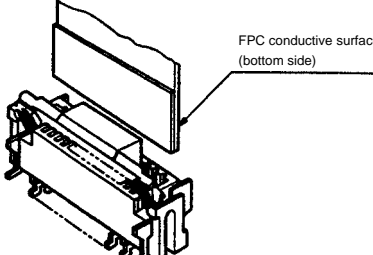
Pitch	Bottom Contact Type	Top Contact Type	Vertical mounting Type
0.5mm	 <p>FH12- ** S-0.5SH P.12 Number of contacts 6, 8, 10, 11, 12, 13, 14, 15, 16, 17, 18, 19, 20, 22, 24, 25, 26, 28, 30, 32, 33, 34, 35, 36, 40, 45, 50, 53</p>		
	<p>Type with Strengthened Lock Lever</p>		
	<p>FH12S- ** S-0.5SH P.13 Number of contacts 30, 40, 45, 50, 53</p>		
	<p>Type with 0.18mm FPC End Thickness</p>		
0.5mm	<p>FH12F- ** S-0.5SH P.14 Number of contacts 6, 8, 10, 12, 13, 14, 15, 16, 18, 20, 22, 24, 25, 26, 28, 30, 32, 34, 36, 40</p>	<p>FH12A- ** S-0.5SH P.15 Number of contacts 10, 12, 15, 16, 18, 20, 22, 24, 26, 28, 29, 30, 32, 33, 34, 36, 40, 42, 45, 50</p>	<p>FH12- ** S-0.5SV P.16 Number of contacts 10, 12, 13, 15, 16, 17, 18, 20, 22, 24, 26, 30, 32, 33, 34, 36, 40, 45, 49, 50, 60</p>
	 <p>Standard FH12- ** S-1SH P.18 Eccentric FH12- ** (***) SA-1SH Standard Number of contacts 5, 6, 7, 8, 9, 11, 12, 16, 17, 22, 26 Eccentric Number of contacts 4, 6, 8, 10, 11, 14, 19, 24</p>		
<p>FH12- ** S-1SV P.19 Number of contacts 6, 7, 8, 16, 20, 22, 24</p>			

0.5mm Pitch Bottom Contact Type

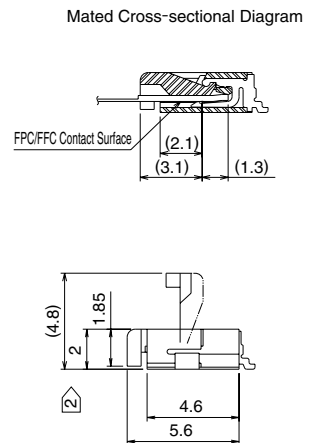
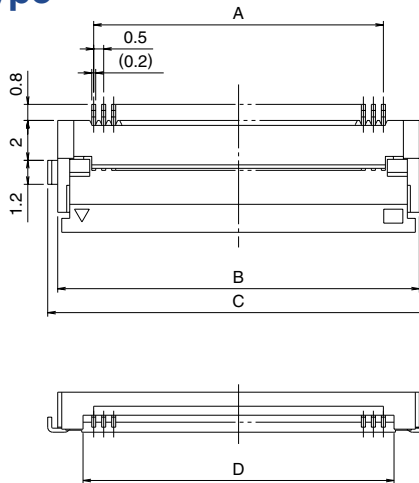

Unit:mm

Part Number	CL No.	Number of Contacts	A	B	C	D	RoHS
FH12- 6S-0.5SH(55)	586-0582-5-55	6	2.5	6.1	7.1	3.57	YES
FH12- 8S-0.5SH(55)	586-0744-5-55	8	3.5	7.1	8.1	4.57	
FH12-10S-0.5SH(55)	586-0522-3-55	10	4.5	8.1	9.1	5.57	
FH12-11S-0.5SH(55)	586-0600-5-55	11	5	8.6	9.6	6.07	
FH12-12S-0.5SH(55)	586-0704-0-55	12	5.5	9.1	10.1	6.57	
FH12-13S-0.5SH(55)	586-0549-0-55	13	6	9.6	10.6	7.07	
FH12-14S-0.5SH(55)	586-0533-0-55	14	6.5	10.1	11.1	7.57	
FH12-15S-0.5SH(55)	586-0523-6-55	15	7	10.6	11.6	8.07	
FH12-16S-0.5SH(55)	586-0531-4-55	16	7.5	11.1	12.1	8.57	
FH12-17S-0.5SH(55)	586-0606-1-55	17	8	11.6	12.6	9.07	
FH12-18S-0.5SH(55)	586-0530-1-55	18	8.5	12.1	13.1	9.57	
FH12-19S-0.5SH(55)	586-0534-2-55	19	9	12.6	13.6	10.07	
FH12-20S-0.5SH(55)	586-0524-9-55	20	9.5	13.1	14.1	10.57	
FH12-22S-0.5SH(55)	586-0532-7-55	22	10.5	14.1	15.1	11.57	
FH12-24S-0.5SH(55)	586-0521-0-55	24	11.5	15.1	16.1	12.57	
FH12-25S-0.5SH(55)	586-0692-3-55	25	12	15.6	16.6	13.07	
FH12-26S-0.5SH(55)	586-0576-2-55	26	12.5	16.1	17.1	13.57	
FH12-28S-0.5SH(55)	586-0612-4-55	28	13.5	17.1	18.1	14.57	
Note ② FH12-30S-0.5SH(55)	586-0525-1-55	30	14.5	18.1	19.1	15.57	
FH12-32S-0.5SH(55)	586-0681-7-55	32	15.5	19.1	20.1	16.57	
FH12-33S-0.5SH(55)	586-0520-8-55	33	16	19.6	20.6	17.07	
FH12-34S-0.5SH(55)	586-0617-8-55	34	16.5	20.1	21.1	17.57	
FH12-35S-0.5SH(55)	586-0740-4-55	35	17.0	20.6	21.6	18.07	
FH12-36S-0.5SH(55)	586-0526-4-55	36	17.5	21.1	22.1	18.57	
Note ② FH12-40S-0.5SH(55)	586-0527-7-55	40	19.5	23.1	24.1	20.57	
Note ② FH12-45S-0.5SH(55)	586-0528-0-55	45	22	25.6	26.6	23.07	
Note ② FH12-50S-0.5SH(55)	586-0529-2-55	50	24.5	28.1	29.1	25.57	
Note ② FH12-53S-0.5SH(55)	586-0595-7-55	53	26	29.6	30.6	27.07	

Note 1 : Embossed tape reel packaging (2,000 pieces/reel).
 Order by number of reels.

Note ② : If there is no problem with the connector height, we recommend the type with the strengthened Flip-lock actuator (FH12S-*S-0.5SH).
 Standard type connector height: 2 mm
 Connector height of type with strengthened Flip-lock actuator: 2.4 mm